

G305

LIGHTSPEED Wireless Gaming Mouse

Souris gaming sans fil LIGHTSPEED

SETUP GUIDE | GUIDE D'INSTALLATION



logitech ™

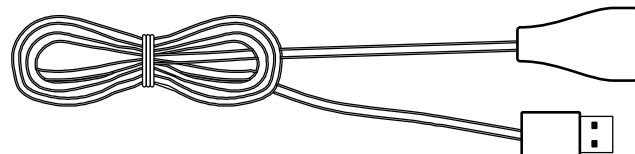
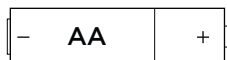
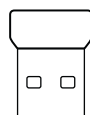

logitech 

Important Safety, Compliance and
Warranty Information
Informations importantes
concernant la sécurité,
la mise en conformité et la garantie

ENGLISH	3
FRANÇAIS	8
ESPAÑOL	13
PORTUGUÊS	18

SETUP INSTRUCTIONS

- 1 Remove the battery cover by pressing the top of the cover and pulling it downwards
- 2 Remove the receiver
- 3 Insert the battery
- 4 Close the battery cover
- 5 Make sure the mouse is turned on via the switch on the bottom of the mouse

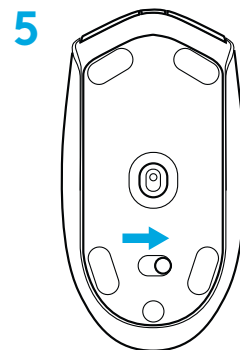
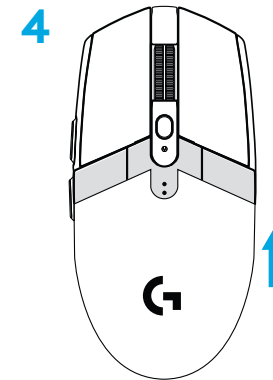
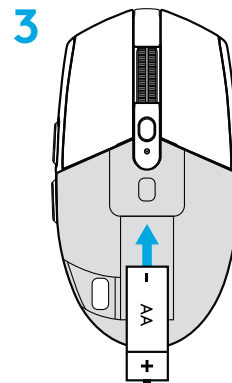
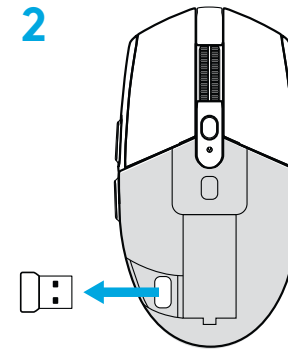
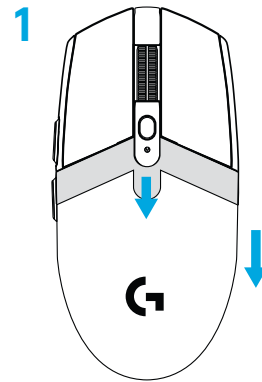

6 Recommended: Insert receiver into the receiver extension cable. Insert extension cable into your USB port. Alternatively, insert receiver directly into your USB port

7 Download the G HUB software

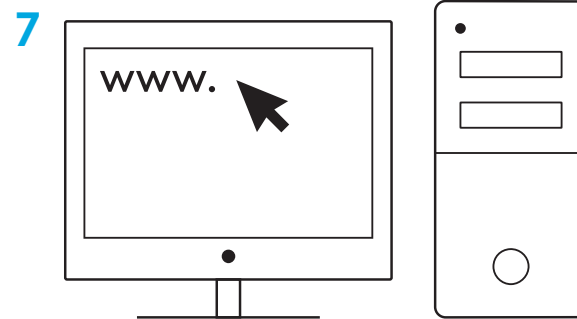
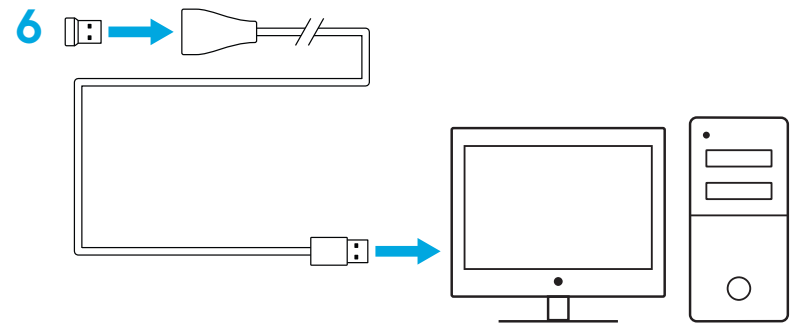

logitechG.com/GHUB

logitechG.com/support

Tips:

- To make your mouse lighter, a lithium AA battery (not included) can be used.
- Keep the mouse and receiver 2 m+ away from wireless routers or other 2.4GHz wireless devices to minimize environmental noise.
- G304 / G305 has a wireless range of up to 10 meters. To ensure optimal performance in noisy wireless environments, it is recommended to keep the receiver within 20 cm of the mouse.

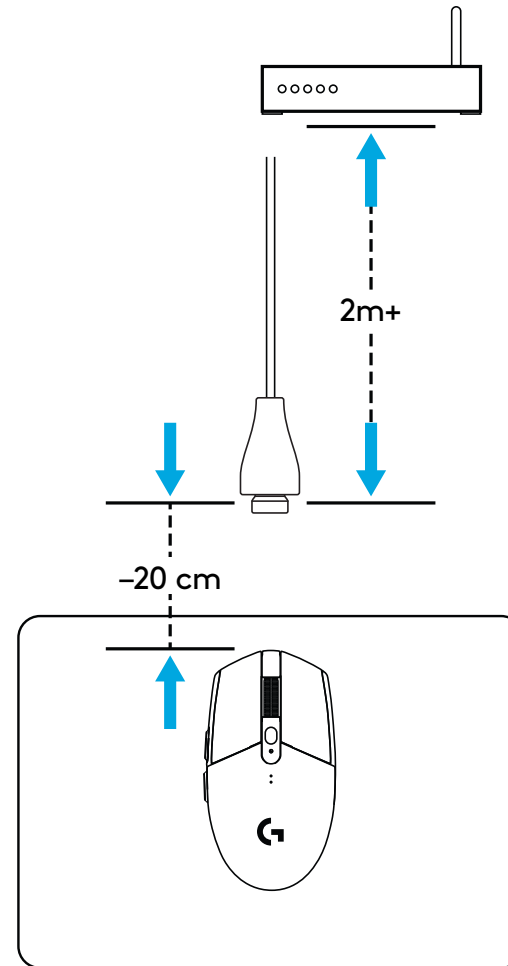
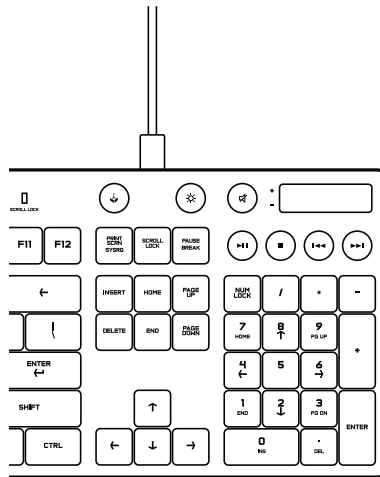

6 FULLY PROGRAMMABLE BUTTONS

- 1 Left (Button 1)
- 2 Right (Button 2)
- 3 Wheel click (Button 3)
- 4 Forward (Button 4)
- 5 Back (Button 5)
- 6 DPI cycle (Button 6)
- 7 On/Off switch (bottom of mouse, not programmable)

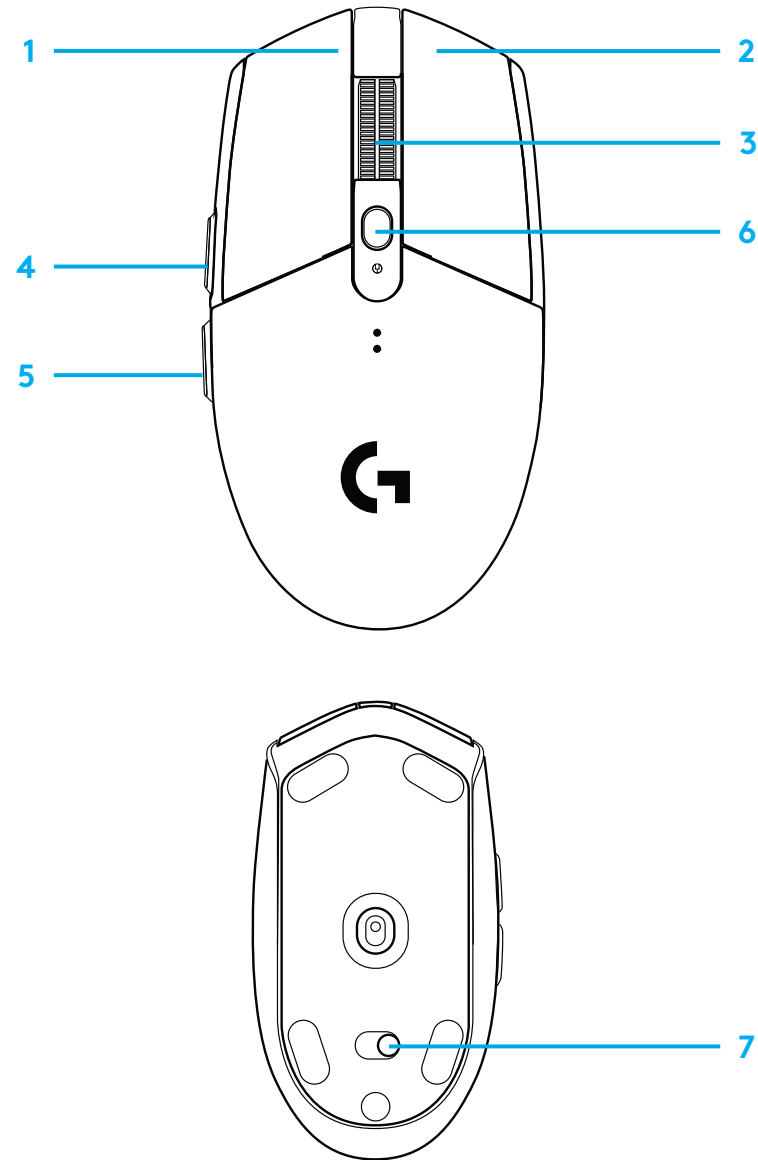

LED INDICATOR

Battery life

Flashing red: battery <15%

DPI

Yellow: step 1 - 400 DPI

White: step 2 - 800 DPI (default)

Orange: step 3 - 1600 DPI

Magenta: step 4 - 3200 DPI

Blue: step 5 - 6400 DPI (Step 5 can be activated via software only)

Mode

Cyan: performance mode (default)

Green: endurance mode (can be activated via software only).

Tips:

- Activating endurance mode will degrade tracking performance but improve battery life.

G HUB SOFTWARE

You can customize the onboard profile settings using the G HUB. These settings include button programming, report rate, performance/endurance modes and tracking behavior. G304 / G305 allows up to 5 DPI settings.

By default, G304 / G305 has the following settings:

- DPI: 400/800/1600/3200
- Report rate: 1ms
- Performance mode

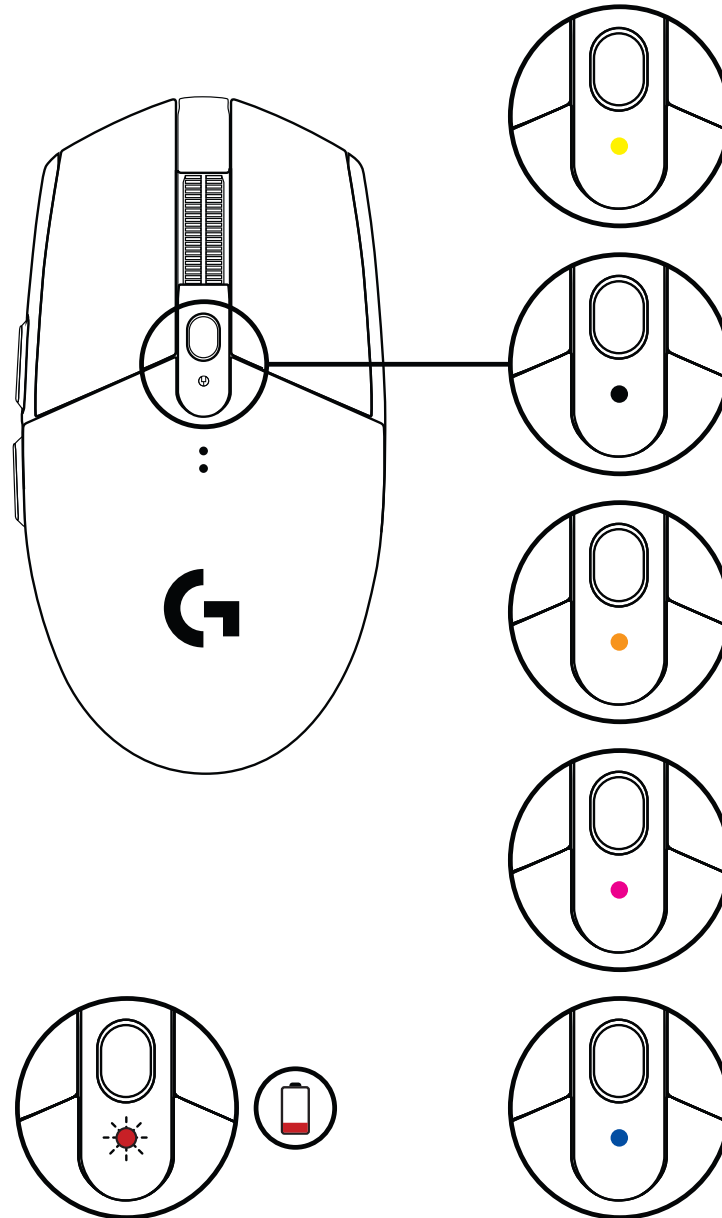

©2020 Logitech. Logitech, Logitech G, Logi and their respective logos are trademarks or registered trademarks of Logitech Europe S.A. and/or its affiliates in the U.S. and other countries. All other trademarks are the property of their respective owners. Logitech assumes no responsibility for any errors that may appear in this manual. Information contained herein is subject to change without notice.

INSTRUCTIONS D'INSTALLATION

- 1 Retirer le couvercle du compartiment à piles en appuyant sur le dessus du couvercle et en le tirant vers le bas
- 2 Retirer le récepteur
- 3 Insérer la batterie
- 4 Refermer le compartiment à piles
- 5 Vérifier que la souris soit sous tension à l'aide du commutateur situé sous la souris

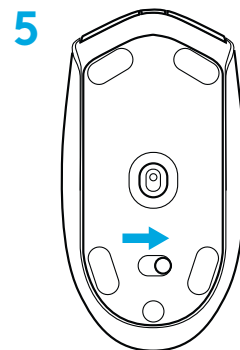
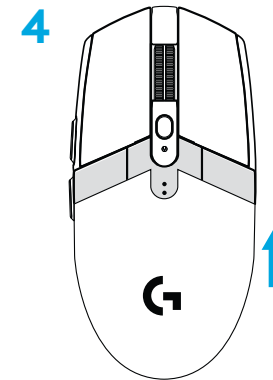
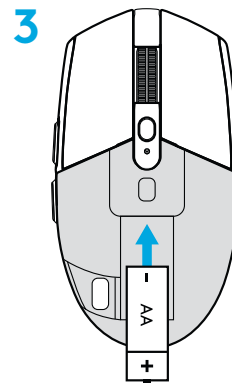
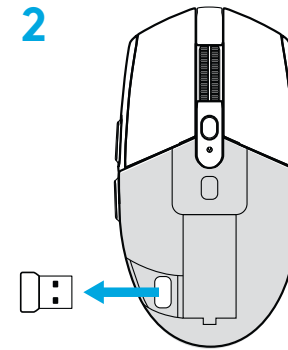
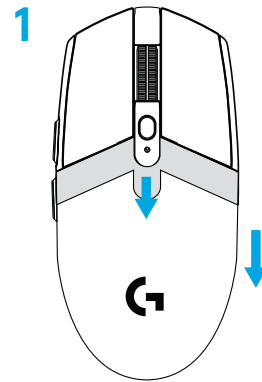

6 Recommandé: Insérez le récepteur dans la rallonge du récepteur. Connectez la rallonge à votre port USB.
Sinon, connecter le récepteur directement à votre port USB

7 Télécharger le logiciel G HUB

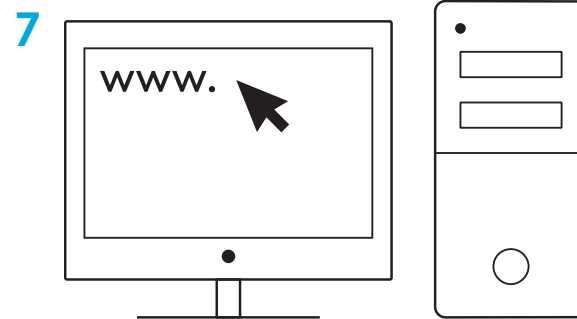
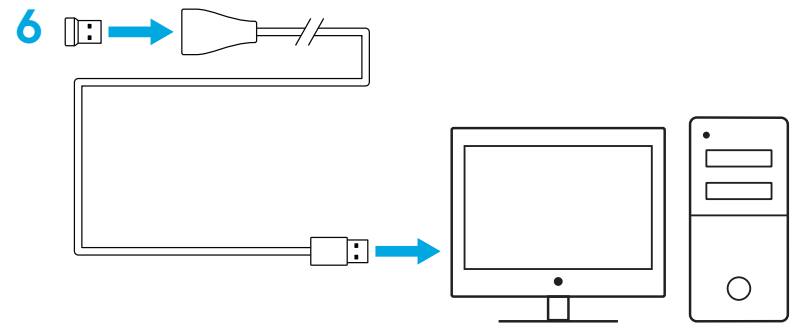

logitechG.com/GHUB

logitechG.com/support

Conseils:

- afin d'alléger votre souris, il est possible d'utiliser une pile AA au lithium (non fournie).
- Tenez la souris et le récepteur à au moins 2 m de tout routeur sans fil ou tout autre dispositif sans fil 2,4 GHz afin de minimiser les interférences.
- La souris G304 / G305 offre une portée sans fil de 10 mètres maximum. Pour une performance optimale dans les environnements sans fil sujets aux interférences, il est recommandé de placer le récepteur à moins de 20 cm de la souris.

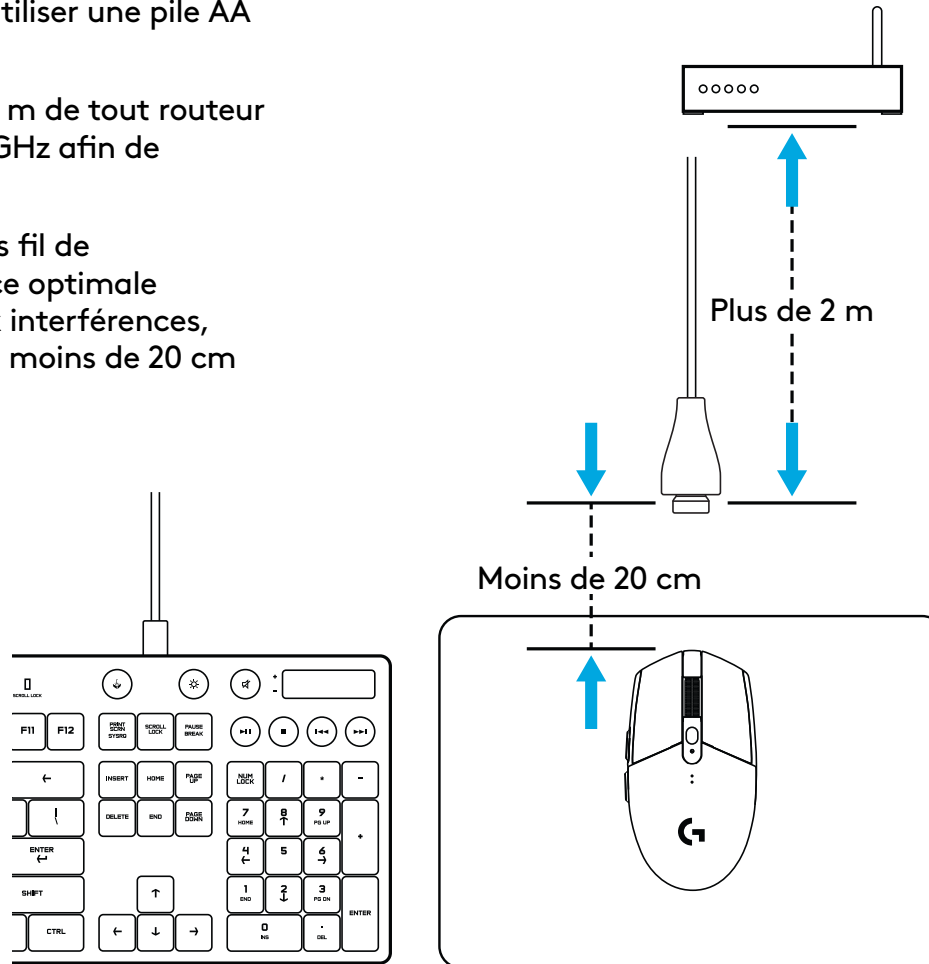

6 BOUTONS ENTIÈREMENT PROGRAMMABLES

- 1 Gauche (bouton 1)
- 2 Droit (bouton 2)
- 3 Clic de roulette (bouton 3)
- 4 Suivant (bouton 4)
- 5 Précédent (bouton 5)
- 6 Cycle de résolution (bouton 6)
- 7 Commutateur Marche/Arrêt (sous la souris, non programmable)

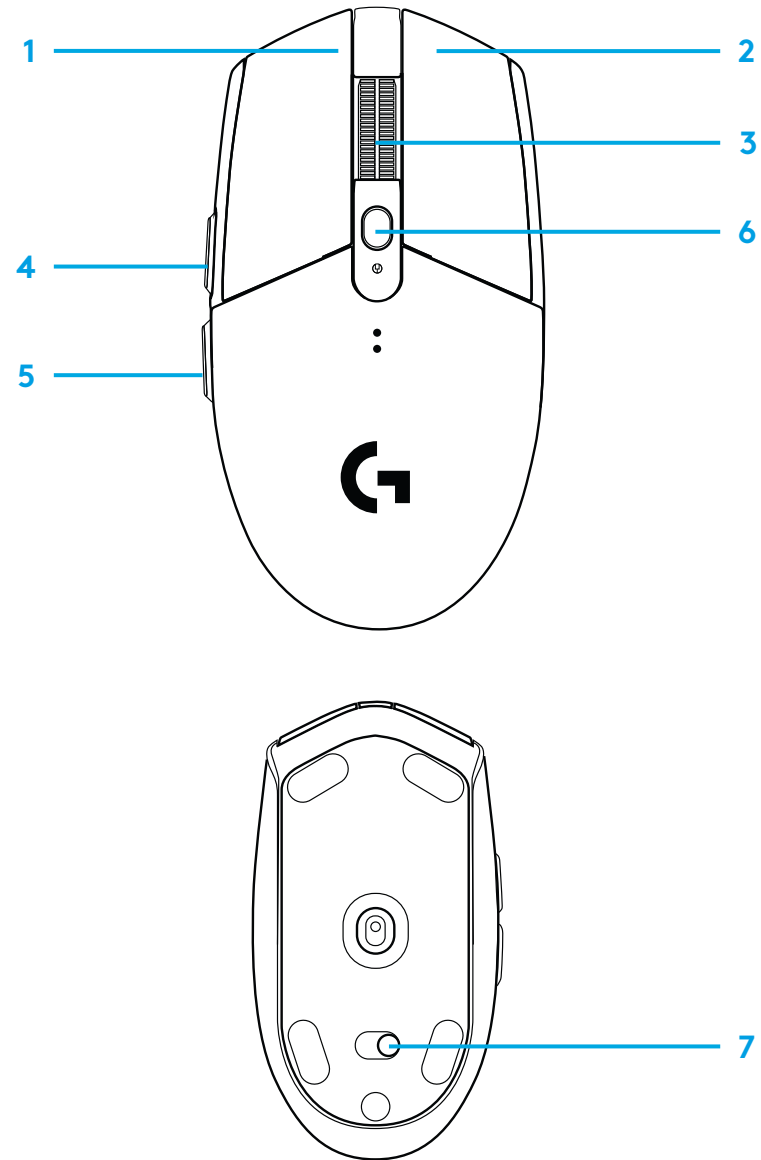

TÉMOIN LUMINEUX

Longévité des piles

Rouge clignotant: <15 %

PPP

Jaune: étape 1 - 400 PPP

Blanc: étape 2 - 800 PPP (valeur par défaut)

Orange: étape 3 - 1 600 PPP

Magenta: étape 4 - 3 200 PPP

Bleu: étape 5 - 6 400 PPP (L'étape 5 peut uniquement être activée via le logiciel)

Mode

Cyan: mode performances (par défaut)

Vert: mode endurance (peut uniquement être activé via le logiciel).

Conseils:

- L'activation du mode endurance réduit les performances de suivi mais améliore la longévité des piles.

LOGICIEL G HUB

Vous pouvez personnaliser les paramètres de profil enregistrés à l'aide de G HUB. Ces paramètres comprennent la programmation des boutons, le taux de rapport, les modes performance/endurance et le comportement de suivi. La souris G304 / G305 peut enregistrer jusqu'à 5 paramètres de résolution.

Par défaut, la souris G304 / G305 propose les paramètres suivants:

- PPP: 400/800/1 600/3 200
- Taux de rapport: 1 ms
- Mode de performances:

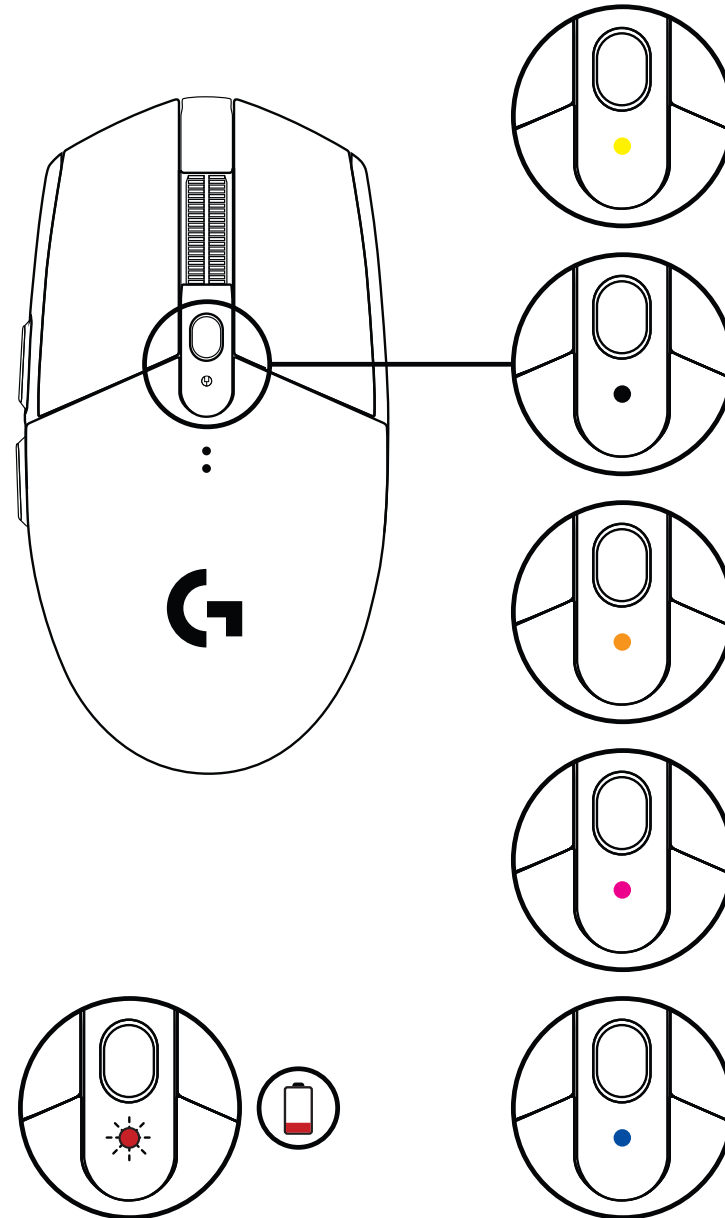

©2020 Logitech. Logitech, Logitech G, Logi et leurs logos respectifs sont des marques commerciales ou déposées de Logitech Europe S.A. et/ou de ses sociétés affiliées aux États-Unis et dans d'autres pays. Toutes les autres marques sont la propriété exclusive de leurs détenteurs respectifs. Logitech décline toute responsabilité en cas d'erreurs susceptibles de s'être glissées dans le présent manuel. Les informations énoncées dans ce document peuvent faire l'objet de modifications sans préavis.

INSTRUCCIONES DE CONFIGURACIÓN

- 1 Retira la tapa del compartimento de la pila pulsando sobre la parte superior y deslizando hacia abajo
- 2 Extrae el receptor
- 3 Coloca la batería
- 4 Cierra la tapa
- 5 Asegúrate de que el mouse esté encendido mediante el conmutador en la parte inferior

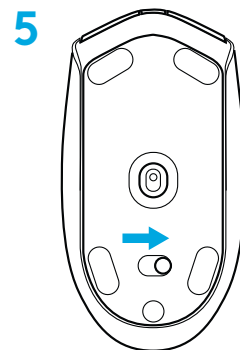
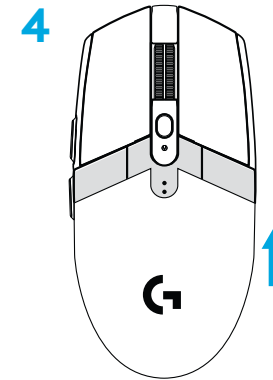
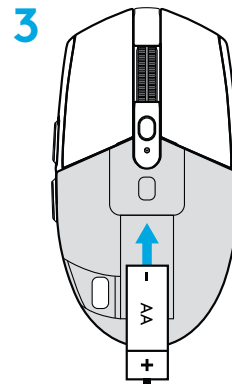
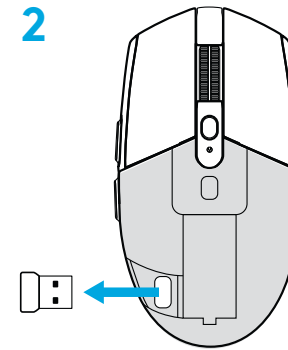
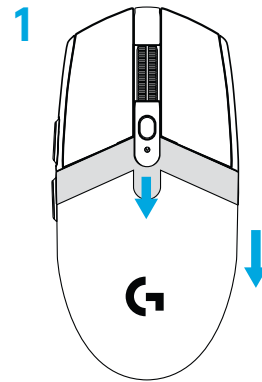

- 6 Recomendado: Inserta el receptor en el cable de extensión del receptor. Inserta el cable de extensión en el puerto USB. Otra posibilidad es insertar el receptor directamente en el puerto USB
- 7 Descarga el software G HUB

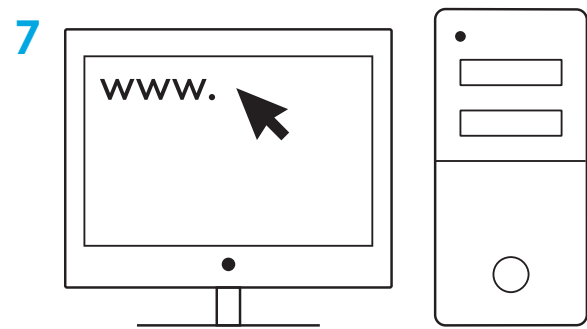
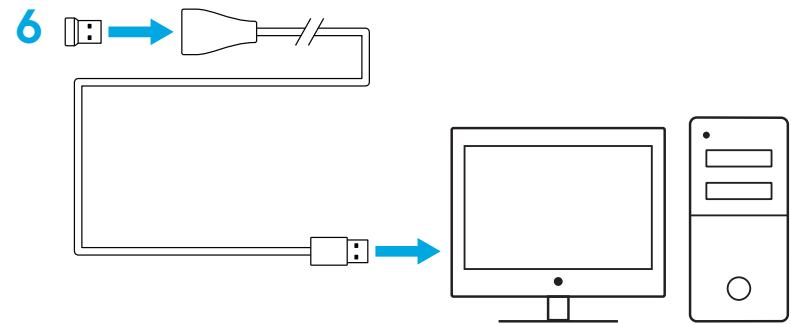

logitechG.com/GHUB
logitechG.com/support

Sugerencias:

- Para que el mouse sea más ligero, puedes usar una batería de litio AA (no incluida).
- Mantén el mouse y el receptor a más de dos metros de enrutadores inalámbricos o de otros dispositivos inalámbricos de 2,4 GHz para minimizar el ruido ambiental.
- G304 / G305 tiene un radio de acción inalámbrico de hasta 10 metros. Para garantizar un rendimiento óptimo en entornos inalámbricos con ruido, es aconsejable mantener el receptor a una distancia máxima de 20 cm del mouse.

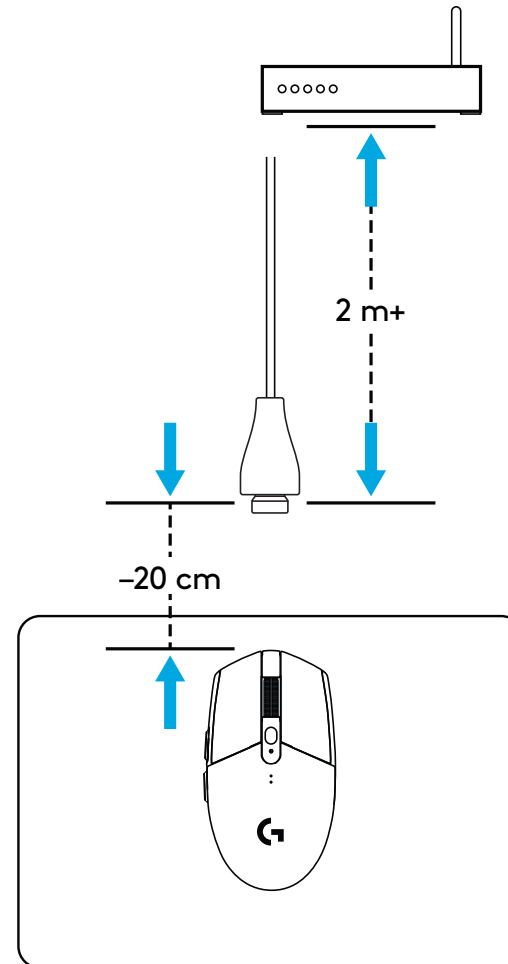
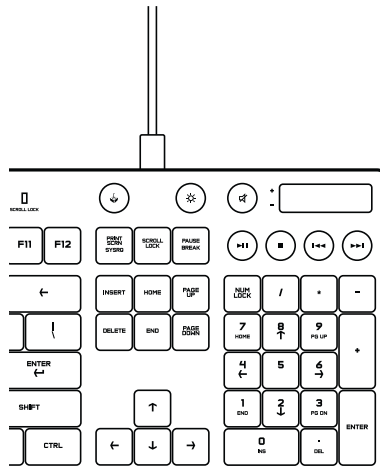

6 BOTONES TOTALMENTE PROGRAMABLES

- 1 Click izquierdo (botón 1)
- 2 Click derecho (botón 2)
- 3 Click con botón rueda (botón 3)
- 4 Avance (botón 4)
- 5 Retroceso (botón 5)
- 6 Ciclo de dpi (botón 6)
- 7 Conmutador de encendido/apagado (parte inferior del mouse, no programable)

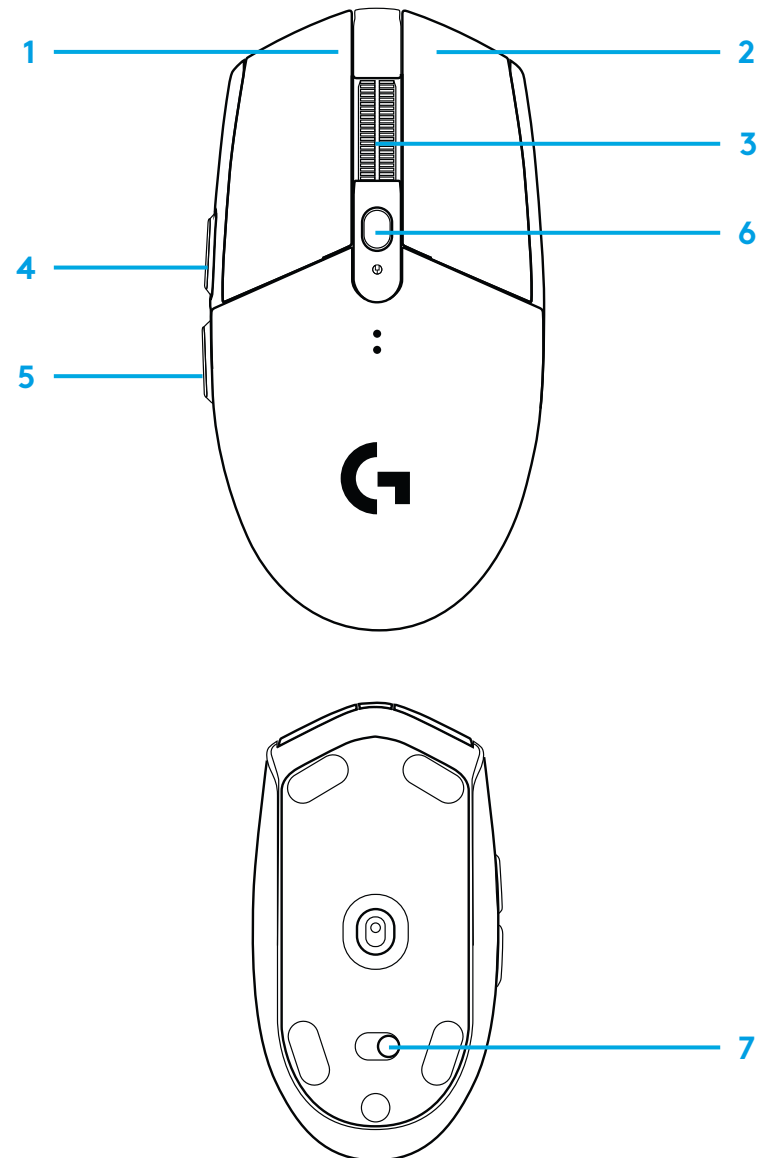

INDICADOR LED

Duración de baterías

Destellos rojos: batería < 15%

dpi

Amarillo: paso 1 - 400 dpi

Blanco: paso 2 - 800 dpi (predeterminado)

Naranja: paso 3 - 1600 dpi

Magenta: paso 4 - 3200 dpi

Azul: paso 5 - 6400 dpi (el paso 5 se puede activar sólo a través del software)

Modo

Cian: modo de desempeño (predeterminado)

Verde: modo de resistencia (se puede activar sólo a través del software).

Sugerencias:

- Al activar el modo de resistencia se reduce el rendimiento de seguimiento pero mejora la duración de la batería.

SOFTWARE G HUB

Puedes personalizar las configuraciones de perfil integradas usando G HUB. Estas configuraciones incluyen programación de botones, velocidad de respuesta, modos de desempeño/resistencia y comportamiento de seguimiento. G304 / G305 permite hasta 5 valores de dpi.

La configuración predeterminada de G304 / G305 es la siguiente:

- dpi: 400/800/1600/3200
- Velocidad de respuesta: 1 ms
- Modo de desempeño

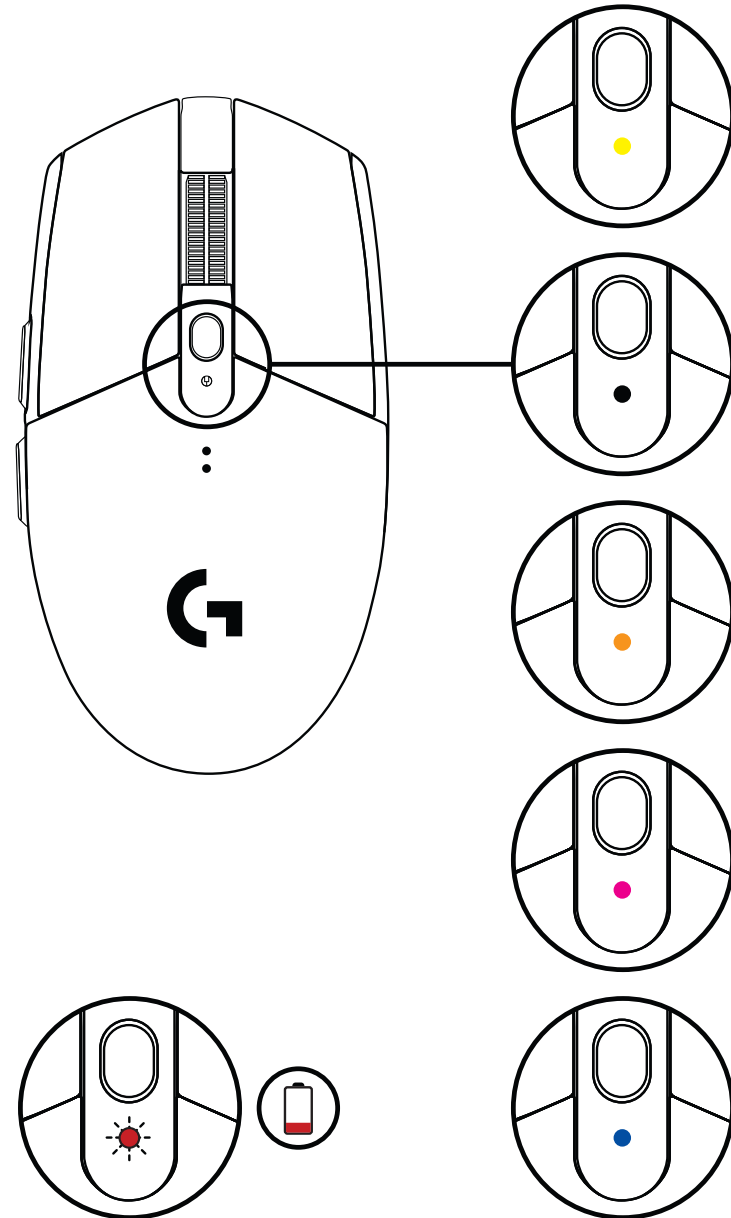

©2020 Logitech. Logitech, Logitech G, Logi y los respectivos logos son marcas comerciales o registradas de Logitech Europe S.A. y/o sus filiales en Estados Unidos y otros países. Las demás marcas comerciales pertenecen a sus respectivos propietarios. Logitech no asume ninguna responsabilidad por la presencia de posibles errores en el presente manual. La información aquí contenida está sujeta a posibles cambios sin previo aviso.

INSTRUÇÕES DE CONFIGURAÇÃO

- 1 Remova a tampa da pilha pressionando a parte superior da tampa e puxando-a para baixo
- 2 Remova o receptor
- 3 Insira a pilha
- 4 Feche a tampa da pilha
- 5 Certifique-se de que o mouse esteja ativado usando o botão na parte inferior do mouse

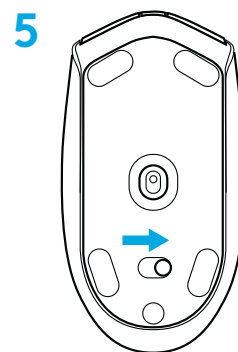
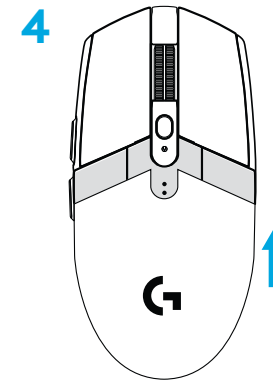
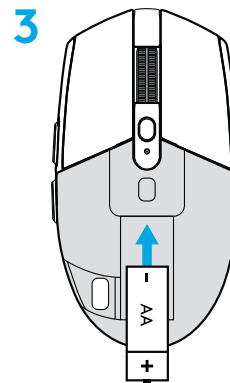
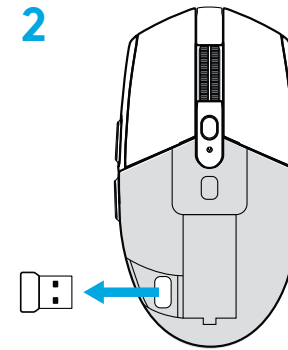
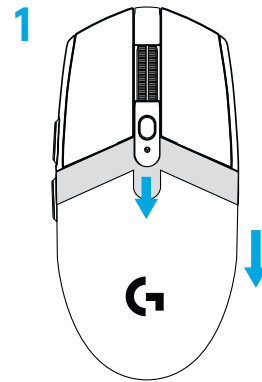

6 Recomendado: Insira o receptor no cabo de extensão do receptor. Insira o cabo de extensão na porta USB. Alternativamente, insira o receptor diretamente na sua porta USB

7 Download do software G HUB

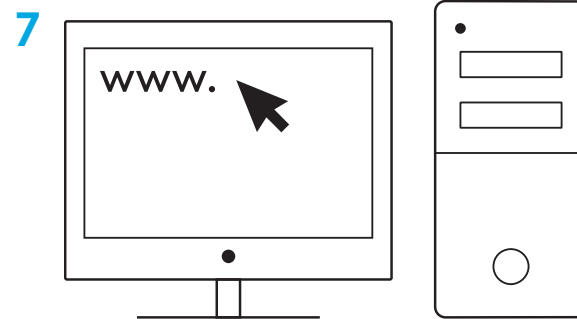
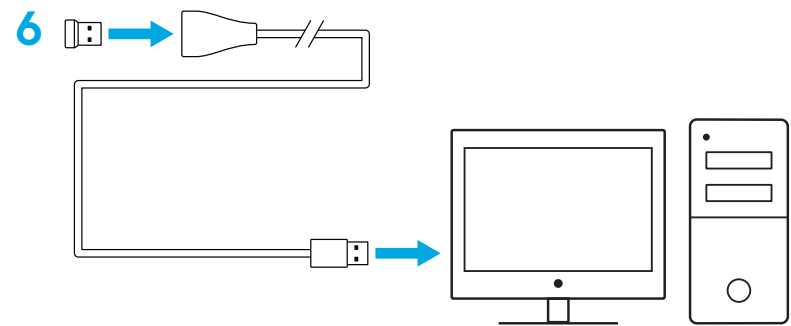

logitechG.com/GHUB

logitechG.com/support

Dicas:

- Para tornar o mouse mais leve, pode ser usada uma bateria AA de lítio (não incluída).
- Mantenha o mouse e o receptor a mais de 2 m de roteadores sem fio ou outros dispositivos sem fio de 2,4 GHz para minimizar a interferência ambiental.
- O G304 / G305 tem um alcance de até 10 metros. Para garantir o melhor desempenho em ambientes sem fio barulhentos, é recomendável que você mantenha o receptor dentro de 20 cm do mouse.

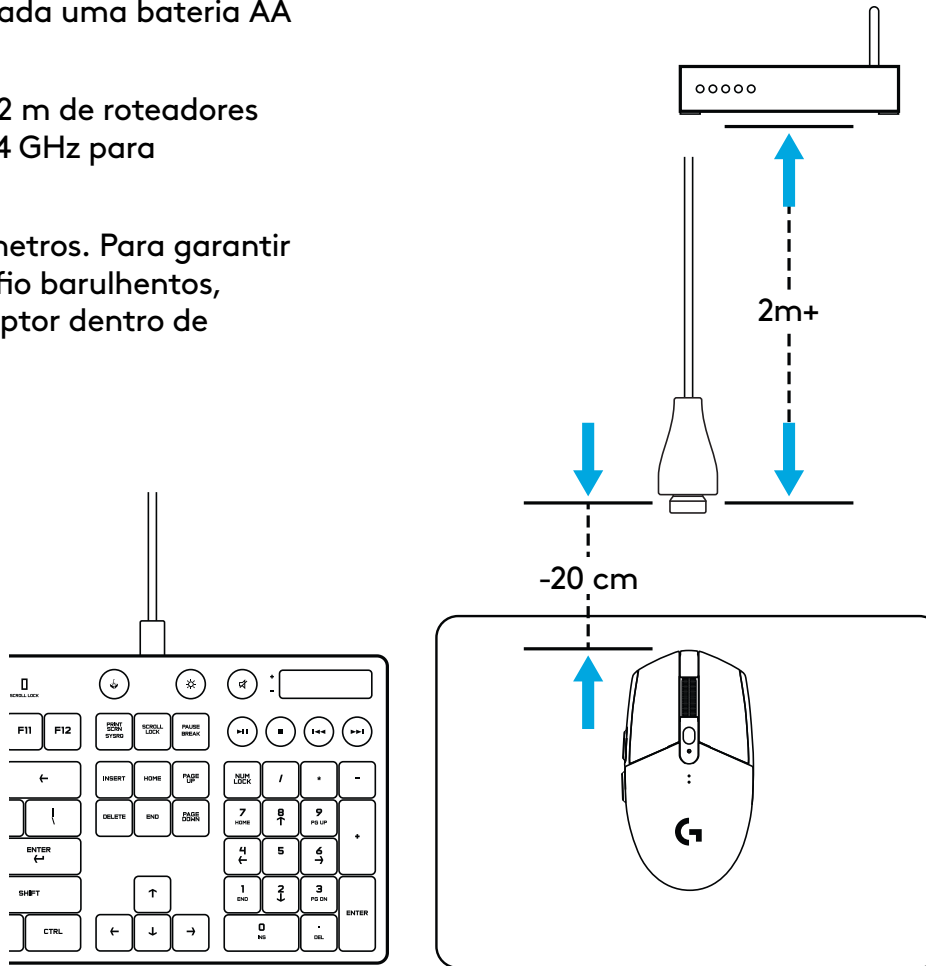

6 BOTÕES TOTALMENTE PROGRAMÁVEIS

- 1 Botão esquerdo (1)
- 2 Botão direito (2)
- 3 Roda de rolagem com clique (3)
- 4 Avançar (4)
- 5 Voltar (5)
- 6 Ciclo de DPI (Botão 6)
- 7 Ligar/desligar (fundo do mouse, não programável)

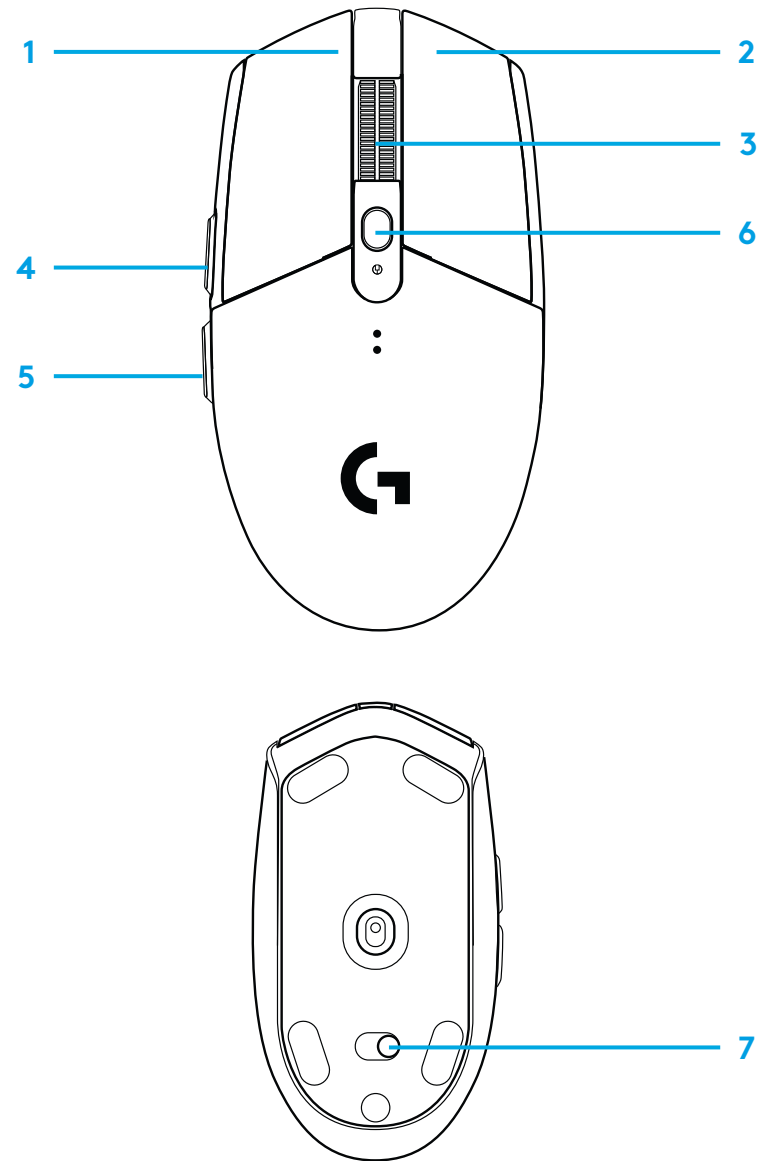

INDICADOR LED

Duração da bateria

Vermelho intermitente: pilha <15%

DPI

Amarelo: passo 1 - 400 DPI

Branco: passo 2 - 800 DPI (padrão)

Laranja: passo 3 - 1600 DPI

Magenta: passo 4 - 3200 DPI

Azul: passo 5 - 6400 DPI (a etapa 5 pode ser ativada apenas através do software)

Modo

Ciano: modo de desempenho (padrão)

Verde: modo endurance (pode ser ativado somente via software).

Dicas:

- Ativar o modo endurance prejudicará o desempenho de rastreamento, mas melhorará a vida útil da bateria.

SOFTWARE G HUB

Você pode personalizar as configurações de perfis internos usando o G HUB. Essas configurações incluem programação de botões, relatório de taxa, modos de desempenho/resistência e comportamento de rastreamento. G304 / G305 permite até 5 configurações de DPI.

Por padrão, o G304 / G305 tem as seguintes configurações:

- DPI: 400/800/1600/3200
- Taxa de resposta: 1 ms
- Modo de desempenho

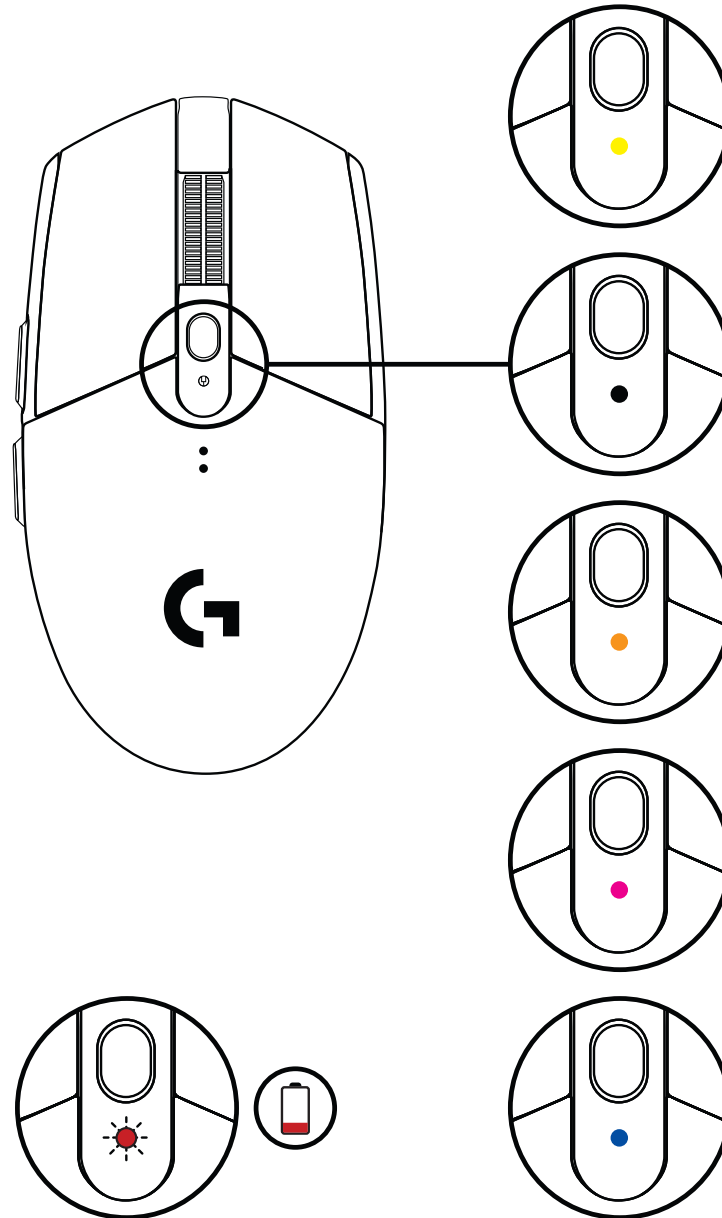

©2020 Logitech. Logitech, Logitech G, Logi e seus respectivos logotipos são marcas comerciais ou marcas registradas da Logitech Europe S.A. e/ou de suas filiais nos EUA e em outros países. Todas as outras marcas comerciais são propriedades dos respectivos titulares. A Logitech não se responsabiliza por quaisquer erros possíveis neste manual. As informações aqui contidas estão sujeitas a alterações sem prévio aviso.



©2020 Logitech. Logitech, Logitech G, Logi and their respective logos are trademarks or registered trademarks of Logitech Europe S.A. and/or its affiliates in the U.S. and other countries. All other trademarks are the property of their respective owners. Logitech assumes no responsibility for any errors that may appear in this manual. Information contained herein is subject to change without notice.

©2020 Logitech. Logitech, Logitech G, Logi et leurs logos respectifs sont des marques commerciales ou déposées de Logitech Europe S.A. et/ou de ses sociétés affiliées aux États-Unis et dans d'autres pays. Toutes les autres marques sont la propriété exclusive de leurs détenteurs respectifs. Logitech décline toute responsabilité en cas d'erreurs susceptibles de s'être glissées dans le présent manuel. Les informations énoncées dans ce document peuvent faire l'objet de modifications sans préavis.

WEB-621-001064.004